

**Overview**

- Touch display with Live Monitor function
- Configurable switching output
- Selectable filters and trigger modes



Picture similar



**Technical data**

**General data**

Type	Distance measuring
Version	OM70 laser line basic
Measuring distance Sd	100 ... 1000 mm
Measuring range Mr	900 mm
Sweet spot	1000 mm
Adjustment	Touch Display, RS485
Power on indication	LED green
Output indicator	LED yellow / LED red
Resolution	3 ... 63 µm
Repeat accuracy	1 ... 32 µm
Linearity error	± 0,19 % Mr
Beam type	Line
Temperature drift	0,065 % Sde/K
Hysteresis digital output	Adjustable

**Light Source**

Light source	Pulsed red laser diode
Wave length	660 nm
Laser class	2

**Electrical data**

Response delay	0,8 ms
Measuring frequency	2500 Hz
Voltage supply range +Vs	15 ... 28 VDC
Current consumption max. (no load)	75 mA
Output circuit	Analog and RS 485
Output signal	4 ... 20 mA / 0 ... 10 VDC

**Electrical data**

Output current	< 100 mA
Switching output	Push-pull
Short circuit protection	Yes
Reverse polarity protection	Yes, Vs to GND

**Communication interface**

Interface	RS485
Baud rate	115200, adjustable

**Mechanical data**

Width / diameter	26 mm
Height / length	74 mm
Depth	55 mm
Type	Rectangular, front view
Housing material	Aluminum
Front (optics)	Glass
Connection types	Connector M12 8 pin
Weight	130 g

**Ambient conditions**

Ambient light immunity	< 100 kLux
Operating temperature	-10 ... +50 °C
Protection class	IP 67
Vibration (sinusoidal)	IEC 60068-2-6:2008 1 mm p-p at f = 10 - 55 Hz, duration 5 min per axis 30 min endurance at f = 55 Hz per axis
Shock (semi-sinusoidal)	IEC 60068-2-27:2009 30 g / 11 ms, 6 jolts per axis and direction

**Remarks**

- Measurement with Baumer standardized measuring equipment and targets (Measurement on 90% remission (white)). Values of Resolution, linearity error and repeat accuracy apply to a measurement with filter setting (Median: 9, Average: 128).

**Dimension drawing**

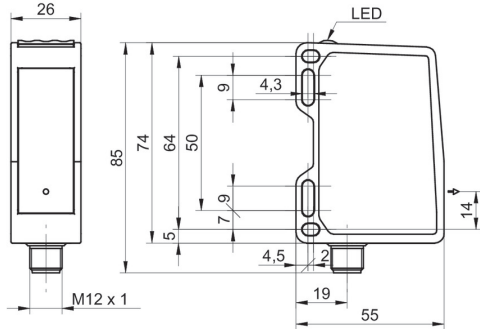

- \* emitter axis

**Laser warning**



**LASER RADIATION**  
**DO NOT STARE INTO BEAM**  
Wavelength: 640...670nm  
IEC 60825-1, Ed. 3, 2014  
**CLASS 2 LASER PRODUCT**

IEC 60825-1/2014 Complies with 21 CFR 1040.10 and 1040.11 except for conformance with IEC 60825-1 Ed. 3., as described in Laser Notice No. 56, dated May 8, 2019

**Connection diagram**

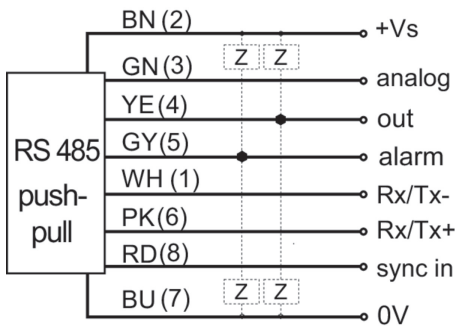

**Pin assignment**

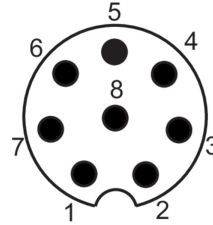

**Beam characteristic (typically)**

