

EN580E.IL-TT14.GB1T2.04096.K

Through hollow shaft, 4096 pulses per revolution

Article number: 11245998

Overview

- Size $\varnothing 58$ mm
- Precise optical sensing
- Output signal level TTL
- Pulses per revolution 4096
- Connection: flange connector M23, 12-pin, CCW

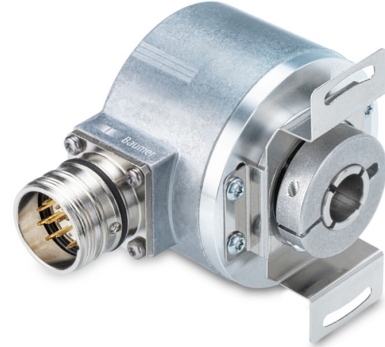

Technical data

Technical data - electrical ratings

Voltage supply	5 VDC ± 5 %
Reverse polarity protection	Yes
Short-circuit proof	Yes (max. 1 s and 1 signal)
Consumption w/o load	≤ 70 mA
Pulses per revolution	4096
Phase shift	$90^\circ \pm 10^\circ$
Duty cycle	40...60 %
Reference signal	Zero pulse, width $90^\circ \pm 10$ %
Sensing method	Optical
Output frequency	≤ 300 kHz (TTL)
Output signals	A+, B+, R+, A-, B-, R-
Output stages	TTL/RS422
Interference immunity	EN 61000-6-2
Emitted interference	EN 61000-6-4
Approval	UL Class 2

Technical data - mechanical design

Size (flange)	$\varnothing 58$ mm
Shaft type	$\varnothing 14$ mm (through hollow shaft)
Motor shaft tolerance	± 0.2 mm (axial offset) ≤ 0.1 mm (radial offset) ≤ 0.1 mm (concentricity)
Protection EN 60529	IP 54 (flange side) IP 65 (housing side)
Operating speed	≤ 6000 rpm (+25 °C)
Starting torque	≤ 0.04 Nm
Material	Housing: aluminium Solid shaft: stainless steel
Operating temperature	-25...+100 °C (see general information)
Relative humidity	95 % non-condensing
Resistance	EN 60068-2-6 Vibration 10 g, 10-2000 Hz EN 60068-2-27 Shock 100 g, 11 ms
Connection	Flange connector M23, 12-pin, CCW
Weight approx.	300 g

General information

Self-heating correlated to installation and ambient conditions as well as to electronics and supply voltage must be considered for precise thermal dimensioning. Operating the encoder close to the maximum limits requires measuring the real prevailing temperature at the encoder flange.

Terminal assignment

Flange socket M23, 12-pin, male contact, CCW

Pin	Assignment
1	B-
2	+Vs Sense
3	R+
4	R-
5	A+
6	A-
7	-
8	B+
9	-
10	0 V
11	0 V Sense
12	+Vs

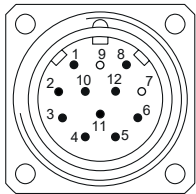

Trigger level

Outputs	TTL/RS422
Output level High	$\geq 2.5 \text{ V}$
Output level Low	$\leq 0.5 \text{ V}$
Load	$\leq 20 \text{ mA}$

Outputs	HTL/Push-pull
Output level High	$\geq U_B - 3 \text{ V}$
Output level Low	$\leq 1.5 \text{ V}$
Load	$\leq 20 \text{ mA}$

Output signals

Clockwise rotating direction when looking at flange.

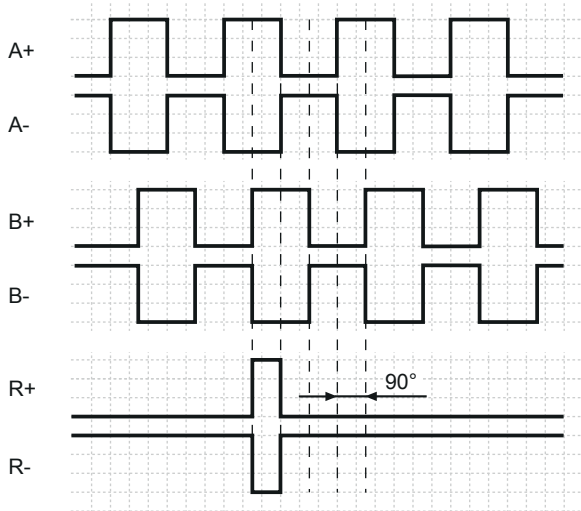

EN580E.IL-TT14.GB1T2.04096.K

Through hollow shaft, 4096 pulses per revolution

Article number: 11245998

Dimensions

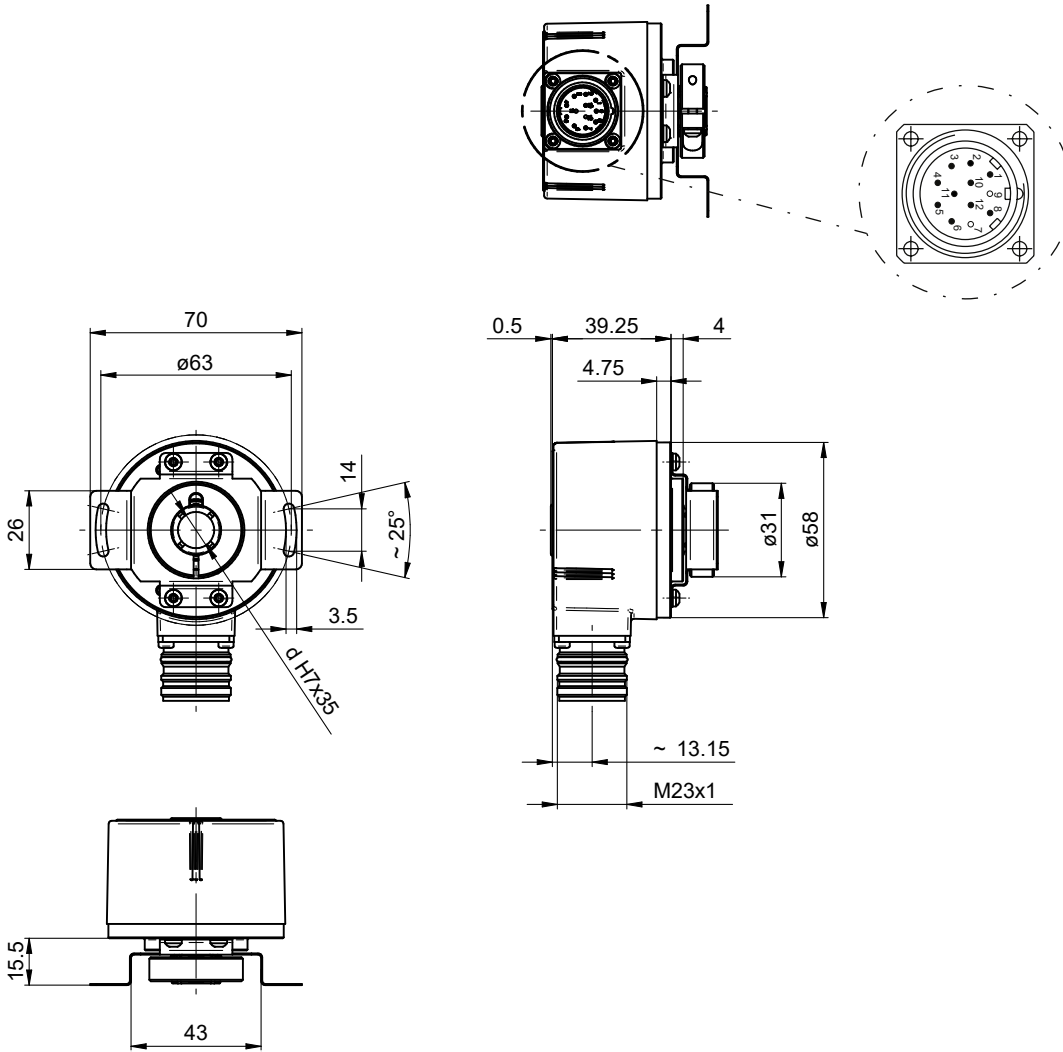

Through hollow shaft, flange socket M23

Accessories**Mounting accessories**

11066083	Mounting kit 006
11073119	Mounting kit 021
11067367	Mounting kit 028
11100198	Mounting kit 046
11113210	Mounting kit 047
11124300	Mounting kit 048
11106627	Fan cover clip 8 mm
11116921	Insulating sleeve \varnothing 10 mm/ \varnothing 12 mm/25 mm long
11116923	Insulating sleeve \varnothing 12 mm/ \varnothing 14 mm/25 mm long