

Diffuse sensors with background suppression

FHDK 14P5104/S35A

dimension drawing

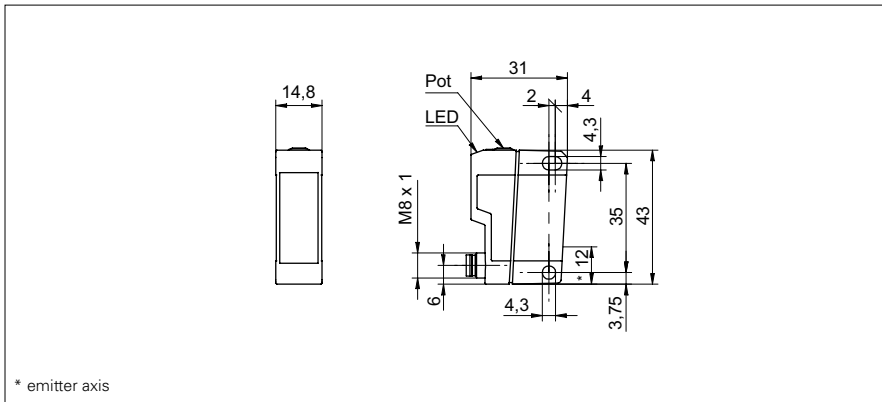

* emitter axis

general data

type	background suppression
light source	pulsed red LED
sensing distance T_w	30 ... 500 mm
sensing range T_b (at T_w max.)	30 ... 500 mm
sensing range T_b (at T_w min.)	5 ... 30 mm
alignment / soiled lens indicator	flashing light indicator
light indicator	LED yellow
sensing distance adjustment	mechanical, 10 turn
wave length	660 nm
suppression of reciprocal influence	yes

electrical data

response time / release time	< 5 ms
voltage supply range +Vs	10 ... 30 VDC
current consumption max. (no load)	30 mA
current consumption typ.	25 mA
voltage drop V_d	< 1,8 VDC
output function	light / dark operate
output circuit	PNP
output current	< 100 mA
short circuit protection	yes
reverse polarity protection	yes

mechanical data

width / diameter	14,8 mm
height / length	43 mm
depth	31 mm
type	rectangular
housing material	plastic (ASA, MABS)
front (optics)	PMMA
connection types	connector M8 4 pin

ambient conditions

operating temperature	-25 ... +65 °C
protection class	IP 67

photo



connection diagram

