

CFDK 25G3125/LN3

Capacitive proximity sensors

Article number: 11092584

Overview

- 4 mm
- push-pull
- no
- cable PVC 3 x 0,14, 2 m
- -25 ... 75 °C
- IP 65



Picture similar



Technical data

General data

Nominal sensing distance Sn	4 mm
Mounting type	Flush
GND electrode	No
Temperature drift	± 15 %
Sensitivity adjustment	No
Output indicator	LED red
Measurement type	Contactless

Field of application

Detection of non-conductive media	No
Fill level detection through container	Yes
Liquids in direct contact	No
Object detection / bulk goods	No

Electrical data

Voltage supply range +Vs	10 ... 30 VDC
Current consumption max. (no load)	15 mA

Electrical data

Output function	Active low
Output circuit	Push-pull
Output current	< 100 mA
Voltage drop Vd	< 3 VDC
Switching frequency	< 35 Hz
Short circuit protection	Yes
Reverse polarity protection	Yes

Mechanical data

Type	Rectangular
Housing material	PA 12
Dimension	25 mm
Housing length	52.4 mm
Depth	6 mm
Connection types	Cable PVC 3 x 0,14, 2 m

Ambient conditions

Operating temperature	-25 ... +75 °C
Protection class	IP 65

CFDK 25G3125/LN3

Capacitive proximity sensors

Article number: 11092584

Dimension drawing

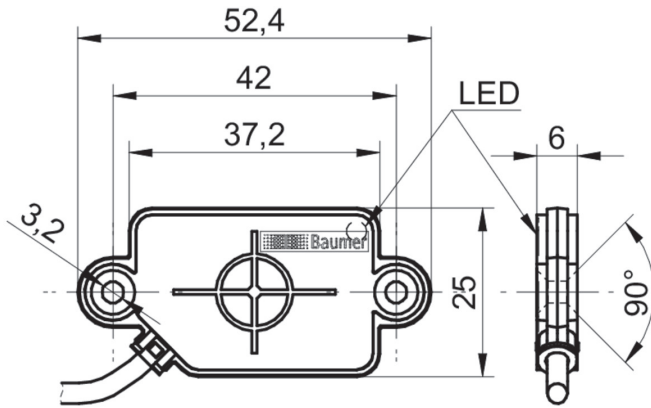

Connection diagram

