

**Overview**

- 0 ... 4 mm
- current output
- connector M12
- -10 ... 70 °C
- IP 67



Picture similar



**Technical data**

**General data**

Mounting type	Quasi-flush
Measuring distance Sd	0 ... 4 mm
Resolution	< 0,001 mm (stat.) < 0,005 mm (dynam.)
Repeat accuracy	< 0,01 mm
Linearity error	± 160 µm
Temperature drift	± 4 % (Full Scale)

**Electrical data**

Response time (factory characteristic)	< 2 ms
Voltage supply range +Vs	15 ... 30 VDC
Output circuit	Current output
Output signal	4 ... 20 mA
Load resistance +Vs min.	< 330 Ohm

**Electrical data**

Load resistance +Vs max.	< 1000 Ohm
Short circuit protection	Yes
Reverse polarity protection	Yes

**Mechanical data**

Type	Cylindrical threaded
Housing material	Brass nickel plated
Dimension	12 mm
Housing length	50 mm
Connection types	Connector M12
Tightening torque max.	15 Nm (Front: 10 Nm)

**Ambient conditions**

Operating temperature	-10 ... +70 °C
Protection class	IP 67

**Remarks**

- Linearity deviation (S = 0,5...4 mm) ± 4% (Full Scale)

# IWRM 12I9704/S14

## Dimension drawing

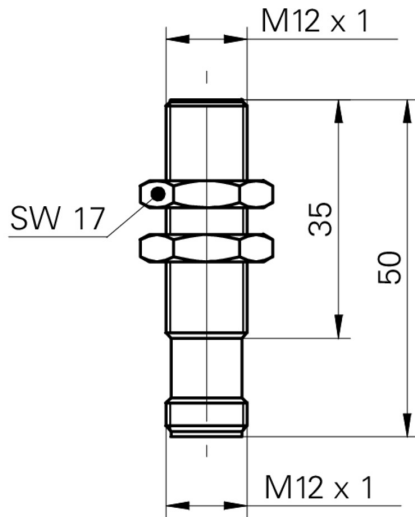

## Installation drawing

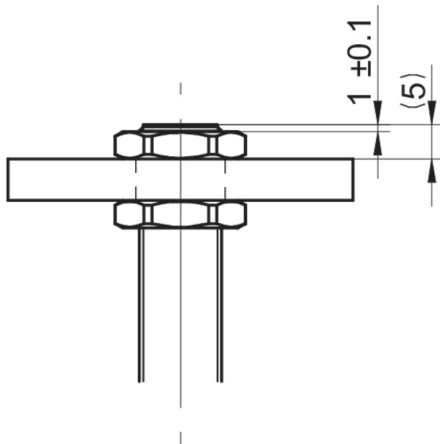

## Connection diagram

