

IFRR 12N13T1/S14L-9

Inductive proximity switch - outdoor and washdown

Article number: 11016089

Overview

- 6 mm
- NPN make function (NO)
- connector M12
- -40 ... 80 °C
- IP 68/69K & proTect+



Picture similar



Technical data

General data

Mounting type	Non-flush
Special type	Outdoor design Washdown design
Nominal sensing distance S _n	6 mm
Hysteresis	2 ... 15 % of S _r
Output indicator	LED red
Approvals/certificates	Ecolab

Electrical data

Switching frequency	< 1 kHz
Voltage supply range +Vs	6 ... 30 VDC
Current consumption max. (no load)	10 mA
Output circuit	NPN make function (NO)
Voltage drop V _d	< 2 VDC
Output current	< 200 mA
Output current (at cleaning temperature)	< 100 mA

Electrical data

Short circuit protection	Yes
Reverse polarity protection	Yes

Mechanical data

Type	Cylindrical threaded
Material (sensing face)	LCP
Housing material	Stainless steel 1.4404 (V4A); LSR
Dimension	12 mm
Housing length	60 mm
Connection types	Connector M12
Tightening torque max.	20 Nm (Front: 14 Nm)

Ambient conditions

Operating temperature	-40 ... +80 °C
Cleaning temperature	80 ... +100 °C (30 min/day)
Protection class	IP 68/69K & proTect+
Vibration resistance	EN 61373: 2010 (category 3), 5h per axis (14.4 gRMS, 10-500 Hz, EN 60068-2-64)
Shock resistance	EN 61373: 2010 (category 3), 10 bumps per axis (100 g, 6 ms, EN 60068-2-27)

Remarks

- Sensor FDA compliant and Ecolab approved
- LSR = Liquid Silicon Rubber

IFRR 12N13T1/S14L-9

Inductive proximity switch - outdoor and washdown

Article number: 11016089

Dimension drawing

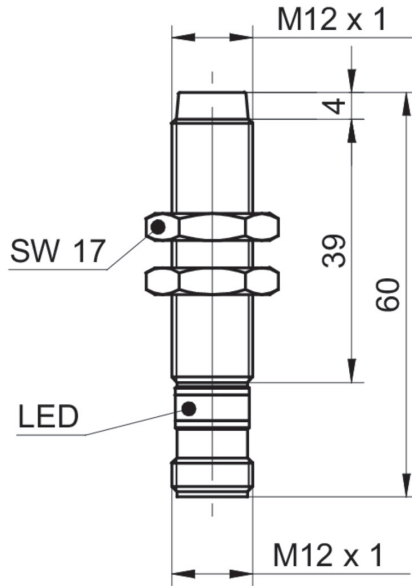

Connection diagram

