

**Overview**

- 18 mm
- NPN complementary (NO / NC)
- connector M12
- -25 ... 75 °C
- IP 67



Picture similar



**Technical data**

**General data**

Mounting type	Flush
Special type	Enhanced distance (GammaProx)
Nominal sensing distance S <sub>n</sub>	18 mm
Temperature drift	± 10 %
Hysteresis	3 ... 20 % of S <sub>r</sub>
Output indicator	3 port LED red
Correction factor typ.	Mild steel 100 %, stainless steel 70 %, aluminum 40 %

**Electrical data**

Switching frequency	< 500 Hz
Voltage supply range +V <sub>s</sub>	6 ... 36 VDC
Current consumption max. (no load)	10 mA
Output circuit	NPN complementary (NO / NC)

**Electrical data**

Voltage drop V <sub>d</sub>	< 2 VDC
Output current	< 200 mA
Short circuit protection	Yes
Reverse polarity protection	Yes

**Mechanical data**

Type	Cylindrical threaded
Material (sensing face)	PBT
Housing material	Brass nickel plated
Dimension	30 mm
Housing length	45 mm
Connection types	Connector M12
Tightening torque max.	140 Nm

**Ambient conditions**

Operating temperature	-25 ... +75 °C
Protection class	IP 67

**Remarks**

- Increased sensing distance
- Complementary output

**Dimension drawing**

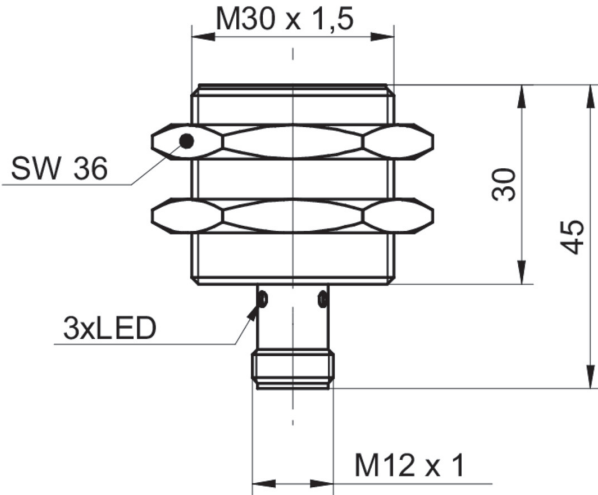

**Connection diagram**

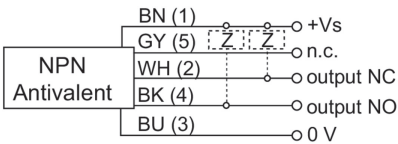

**Correction factors for different mounting situation (approx.)**

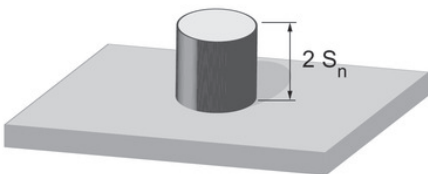

Mounting material	Correction factor
Mild steel	100 %
Stainless steel	100 %
Aluminum	100 %

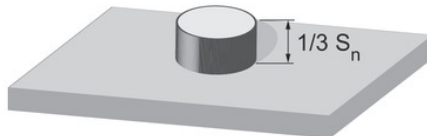

Mounting material	Correction factor
Mild steel	105 %
Stainless steel	105 %
Aluminum	100 %

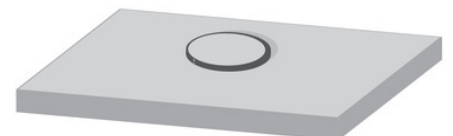

Mounting material	Correction factor
Mild steel	not possible
Stainless steel	not possible
Aluminum	75 %

**Mounting instructions**

