

Overview

- 15 mm
- NPN make function (NO)
- connector M12
- 65 °C
- IP 67



Picture similar



Technical data

General data	
Mounting type	Non-flush
Special type	Enhanced distance (GammaProx)
Nominal sensing distance Sn	15 mm
Temperature drift	- 5 % / + 10 % (+10 ... +60 °C) - 5 % / + 15 % (0 ... +65 °C)
Hysteresis	3 ... 20 % of Sr
Output indicator	3 port LED red
Correction factor typ.	Mild steel 100 %, stainless steel 85 %, aluminum 55 %
Electrical data	
Switching frequency	< 400 Hz
Voltage supply range +Vs	6 ... 36 VDC
Current consumption max. (no load)	10 mA
Output circuit	NPN make function (NO)

Electrical data	
Voltage drop Vd	< 2 VDC
Output current	< 100 mA
Short circuit protection	Yes
Reverse polarity protection	Yes

Mechanical data	
Type	Cylindrical threaded
Material (sensing face)	PBT
Housing material	Brass nickel plated
Dimension	18 mm
Housing length	60 mm
Connection types	Connector M12
Tightening torque max.	40 Nm

Ambient conditions	
Operating temperature	0 ... +65 °C
Protection class	IP 67

Remarks

- Increased sensing distance

Dimension drawing

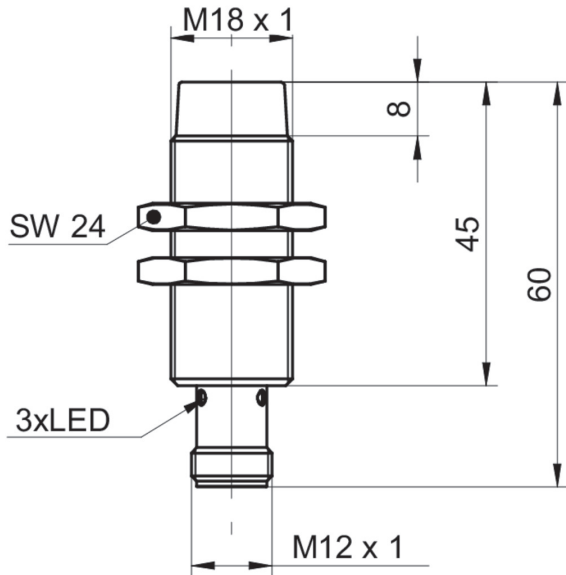

Connection diagram

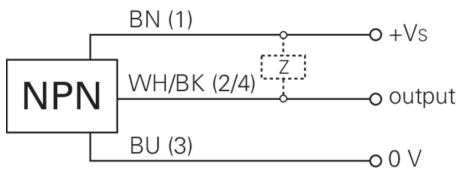

Correction factors for different mounting situation (approx.)

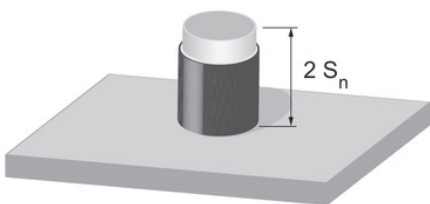

Mounting material	Correction factor
Mild steel	100 %
Stainless steel	100 %
Aluminum	100 %

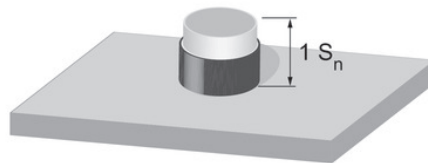

Mounting material	Correction factor
Mild steel	105 %
Stainless steel	100 %
Aluminum	100 %

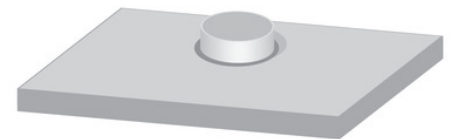

Mounting material	Correction factor
Mild steel	not possible
Stainless steel	115%
Aluminum	95 %

Mounting instructions

