

**Overview**

- 6 mm
- NPN make function (NO)
- cable, 2 m
- -25 ... 75 °C
- IP 67



Picture similar



**Technical data**

**General data**

Mounting type	Flush
Special type	Enhanced distance (GammaProx)
Nominal sensing distance Sn	6 mm
Temperature drift	± 10 %
Hysteresis	3 ... 20 % of Sr
Output indicator	LED red
Correction factor typ.	Mild steel 100 %, stainless steel 75 %, aluminum 45 %

**Electrical data**

Switching frequency	< 1 kHz
Voltage supply range +Vs	6 ... 36 VDC
Current consumption max. (no load)	10 mA
Output circuit	NPN make function (NO)

**Electrical data**

Voltage drop Vd	< 2 VDC
Output current	< 100 mA
Short circuit protection	Yes
Reverse polarity protection	Yes

**Mechanical data**

Type	Cylindrical threaded
Material (sensing face)	PBT
Housing material	Brass nickel plated
Dimension	12 mm
Housing length	40 mm
Connection types	Cable, 2 m
Tightening torque max.	15 Nm (A: 10 Nm)

**Ambient conditions**

Operating temperature	-25 ... +75 °C
Protection class	IP 67

**Remarks**

- Triple sensing distance

**Dimension drawing**

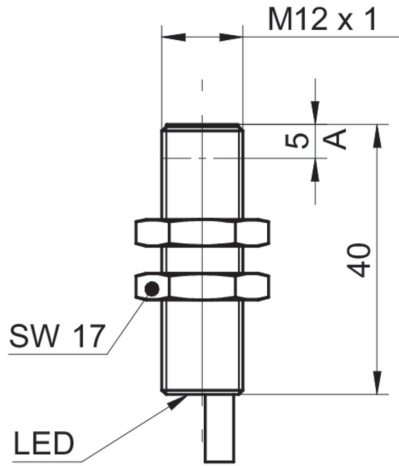

**Connection diagram**



**Correction factors for different mounting situation (approx.)**

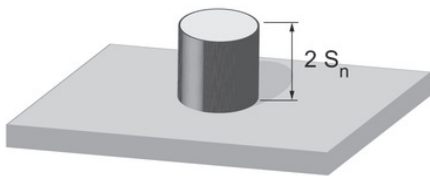

Mounting material	Correction factor
Mild steel	100 %
Stainless steel	100 %
Aluminum	100 %

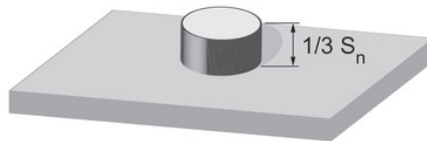

Mounting material	Correction factor
Mild steel	100 %
Stainless steel	95 %
Aluminum	95 %

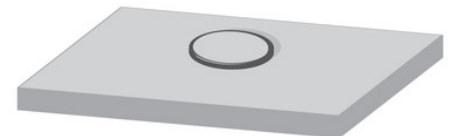

Mounting material	Correction factor
Mild steel	not possible
Stainless steel	95 %
Aluminum	80 %

**Mounting instructions**

