

Overview

- 8 mm
- PNP make function (NO)
- cable, 2 m
- -25 ... 75 °C
- IP 67



Picture similar



Technical data

General data

Mounting type	Quasi-flush
Nominal sensing distance S _n	8 mm
Hysteresis	3 ... 20 % of S _r
Output indicator	LED red

Electrical data

Switching frequency	< 500 Hz
Voltage supply range +V _s	6 ... 36 VDC
Current consumption max. (no load)	10 mA
Output circuit	PNP make function (NO)
Voltage drop V _d	< 2 VDC
Output current	< 200 mA

Electrical data

Short circuit protection	Yes
Reverse polarity protection	Yes

Mechanical data

Type	Cylindrical threaded
Material (sensing face)	PBT
Housing material	Brass nickel plated
Dimension	18 mm
Housing length	65 mm
Connection types	Cable, 2 m
Tightening torque max.	40 Nm

Ambient conditions

Operating temperature	-25 ... +75 °C
Protection class	IP 67

Remarks

- Not for flush mounting in mild steel

IFRM 18P17A4/L

Inductive proximity switch - standard

Article number: 11111676

Dimension drawing

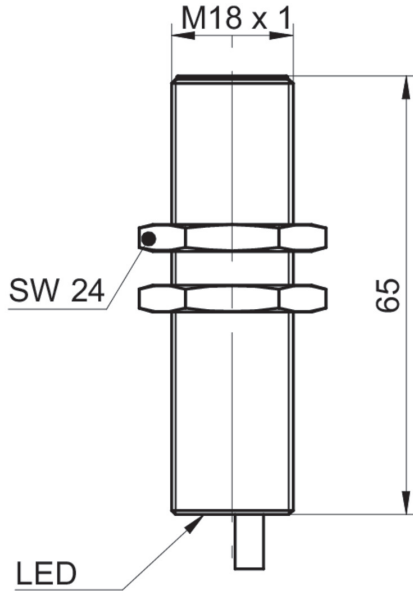

Connection diagram

